

## ITEM 103247 N1AR514AM-MC2222

Description	Technical data	Accessories	Downloads
-------------	----------------	-------------	-----------



### Features

- › Plunger material stainless steel
- › Housing according to DIN 43693
- › Low temperature down to -30°C
- › With safety switching element, silicone diaphragm (internal and external) and low-temperature grease

### Low temperature

Version C2222 with silicone membrane and low temperature grease.

### Switching element

**514** Snap-action switching contact 1 NC  $\rightarrow$  + 1 NO

⚠ To achieve the positively driven travel, the dimension  $\text{12}_{-0.5}$  must be maintained by the trip dog. Actuating elements such as dog approach guides must be firmly mounted in accordance with EN ISO 14119, i.e. riveted, welded or otherwise secured against becoming loose.

## Approvals



## Mechanical values and environment

Contact bounce time	≤ 3ms
Contact closing time	≤ 5ms
Design	Housing according to DIN 43693
Housing material	Anodized die-cast alloy
Weight	
Net	0,2 kg
Ambient temperature	-30 ... 80 °C
Degree of protection	IP67
Mechanical life	1 x 10 <sup>6</sup>
Contact material	Silver alloy, gold flashed
Switching principle	Snap-action switching contact
Installation position	Any
Number of switching elements	1
Number of positively driven contacts	1
Number of NO contacts	1
Connection	
2 x	M16 x 1.5
Approach speed	
max.	0,01 ... 80 m/min
Actuating element	Roller plunger
Roller diameter	5 mm
Actuating force	min.30 N

## Electrical connection ratings

Rated thermal current I <sub>th</sub>	10 A
Utilization category according to EN 60947-5-1	
AC-15	2.5A 230V
DC-13	6A 24V
Short circuit protection according to IEC 60269-1	
(Fuse)	6A gG
Rated insulation voltage U <sub>i</sub>	250 V
Rated impulse withstand voltage U <sub>imp</sub>	4 kV
Switching current	
Min. at DC 24V	5 mA
Connection cross-section	0,34 ... 1,5 mm <sup>2</sup>

## Miscellaneous

C number	C2222	[1]
Additional information	Exterior diaphragm = AM. [2]	

## Reliability values acc. to EN ISO 13849-1

	Monitoring of the safety guard position
B10 <sub>D</sub>	20 x 10 <sup>6</sup>

---

[1] With silicone diaphragm + low temperature grease. For low ambient temperatures down to -30°C.

[2] The exterior diaphragm provides additional protection to the plunger guide. Plunger sticking, primarily caused by resinous lubricating coolants, can be prevented by this exterior diaphragm version.



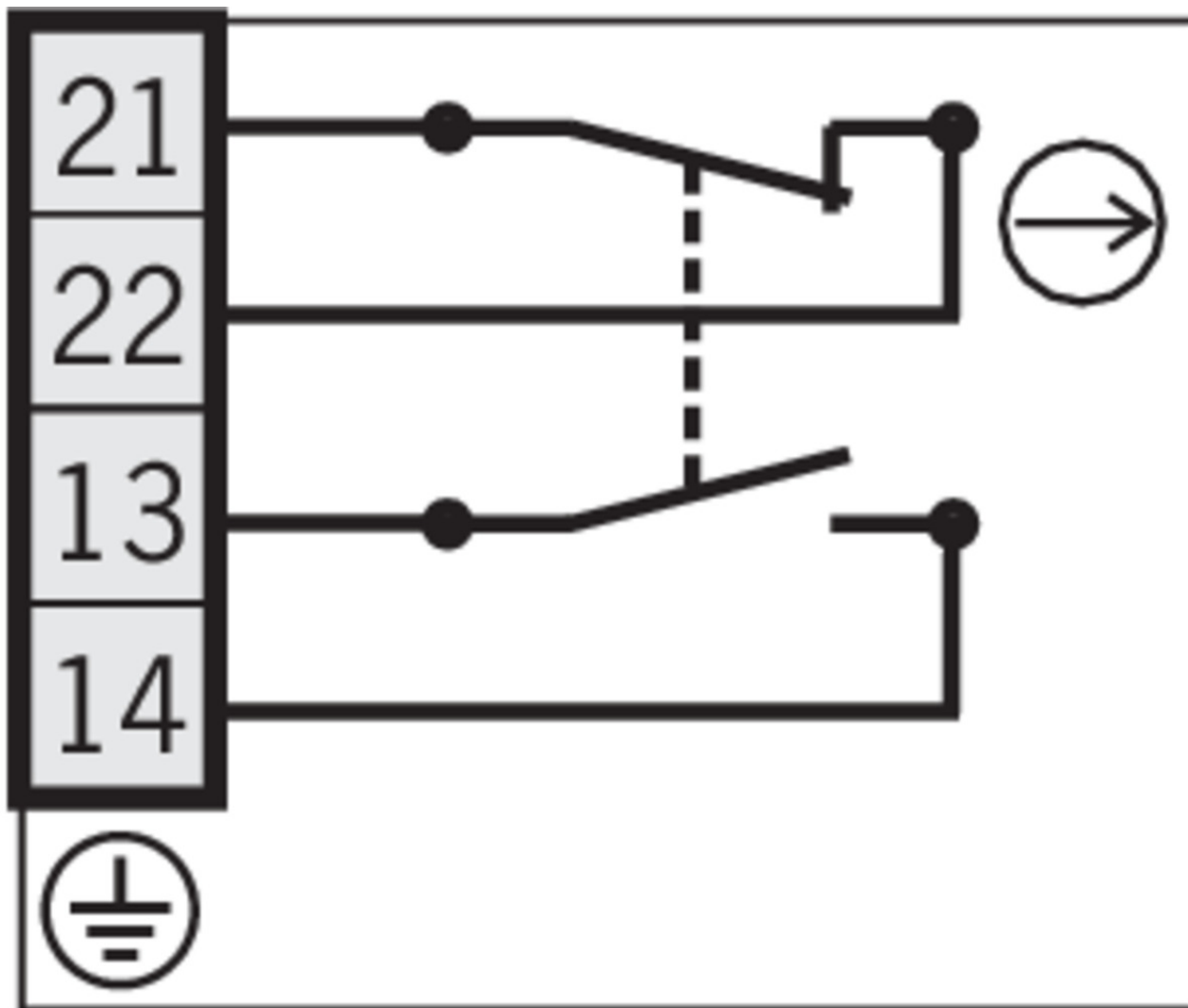

### Instructions







- Manual de instrucciones Finales de carrera unitarios de precisión N1A

	Doc. no.	Version	Language	Download
Betriebsanleitung Präzisions-Einzelgrenztaster N1A Operating Instructions Precision Single Limit Switches N1A	2032309	12-01/18		0.8 MB
Mode d'emploi Monopistes de précision N1A	2032309	12-01/18		0.4 MB
Manual de instrucciones Finales de carrera unitarios de precisión N1A	2032309	12-01/18		0.4 MB
Istruzioni di impiego Finecorsa di precisione singoli N1A	2032309	12-01/18		0.4 MB

### Catalogs

- Positionsschalter und Reihengrenztaster Position Switches and Multiple Limit Switches

## Interrupteurs de position et boîtiers multipistes

	Doc. no.	Version	Language	Download
Positionsschalter und Reihengrenztaster	157835	01-03/18		 4.1 MB
Interrupteurs de position et boîtiers multipistes	157837	01-03/18		 4.1 MB
Position Switches and Multiple Limit Switches	157836	01-03/18		 4.1 MB

## Declaration of conformity

### EU prohlášení o shodě

	Doc. no.	Version	Language	Download
EU-Konformitätserklärung Declaración UE de conformidad Déclaration UE de conformité Dichiarazione di conformità EU declaration of conformity	2077153	25-02/17	    	 0.3 MB
EU prohlášení o shodě EU-overensstemmelseserklæring Δήλωση συμμόρφωσης της ΕΕ EU-vaatimustenmukaisuusvakuutus EU-típusbizonyítvány EU-conformiteitsverklaring Deklaracja zgodności UE Declaração de Conformidade UE Declarația de conformitate UE EÚ vyhlásenie o zhode	2077153	25-02/17	         	 0.5 MB