

Technical data sheet

Load monitoring · LOCC-Box-M

Electronic load monitoring up to DC 8 A

Single-channel design, Adjustable current range: DC 1 A – 8 A

Adjustable characteristics, fast, medium, slow 1, -2, -3



Identification

Type	LOCC-Box-M
Part No.	716480

Product version

Datasheet version	01
-------------------	----

Input

Type of function	1-channel 1 pin switching
Rated voltage U_N	DC 12/24 V
Operation voltage range	DC 10–30 V
Rated current I_N	DC 8 A
Reverse voltage protection	internal electronics

Control input (Set / Reset)

Signal level	DC 12/24 V acc. to EN 61131
OFF	Pulse with falling edge >100 ms, <800 ms
ON	Pulse with falling edge > 1 s

Output

Switching element	MOSFET
Output current	max. DC 8 A
Voltage drop	max. 180 mV (8 A)
Status display output	LED green: operating voltage present, no error LED red: error in load circuit

United Kingdom: LÜTZE Ltd.

Unit 3, Sandy Hill Park
Sandy Way, Amington • GB-Tamworth, Staffs B77 4DU
Tel. +44 (0)1827 31333-0 • Fax +44 (0)1827 31333-2
www.lutze.com • sales.gb@lutze.co.uk

Germany: Friedrich Lütze GmbH

Postfach 12 24 (PLZ 71366) • Bruckwiesenstraße 17-19 • D-71384 Weinstadt
Tel. +49 (0)7151 6053-0 • Fax +49 (0)7151 6053-277(-288)
www.luetze.de • info@luetze.de

01.02.2023 • Subject to technical modification

Part No. [716480](#) • Datasheet version: 01

page 1 of 6



SYSTEMATIC TECHNOLOGY

Technical data sheet

Load monitoring · LOCC-Box-M

Switch-on capacity	10000 μ F
Current range	1 A – 8 A (adjustable via switch)
Characteristic	fast (1), medium (2), slow 1 (3), slow 2 (4), slow 3 (5) see 'characteristic curves'

Signal output

Signal level	DC 12/24 V: operating voltage on standby, no error, DC 0 V: error, output switched off or manual "OFF"
Switching element	Transistor, collector with pull-up resistance

General

Dimensions (w × h × d)	8.1 mm × 87.0 mm × 92.0 mm
Housing material	PA 6.6 (UL 94 V-0, NFF I2, F2)
Color of the housing	basalt grey
Mounting	DIN rail mountable TS35 (EN 60715)
Installation position	Any
MTBF	690000 h
Degree of protection	IP20
Connection type	Push-In 0.25 mm ² – 2.5 mm ² AWG 24 – AWG 14
Weight/unit	0.06 kg
PU (units)	1

General ambient conditions

Operation temperature range	-25 °C ... +50 °C
Storage temperature range	-40 °C ... +85 °C
Relative air humidity	10 % – 95 %, without condensation
Vibration resistance	4 g acc. to EN 60068-2-6
Shock resistance	15 g acc. EN 60068-2-27

Certifications/Standards

Conformity	CE UKCA
Certifications	FCC Part 15 Class B cULus (E135145) URus (E490188)
Standards	EN 61000-6-2 EN 61000-6-4 UL 60947-5-1 UL 2367

Dimensions

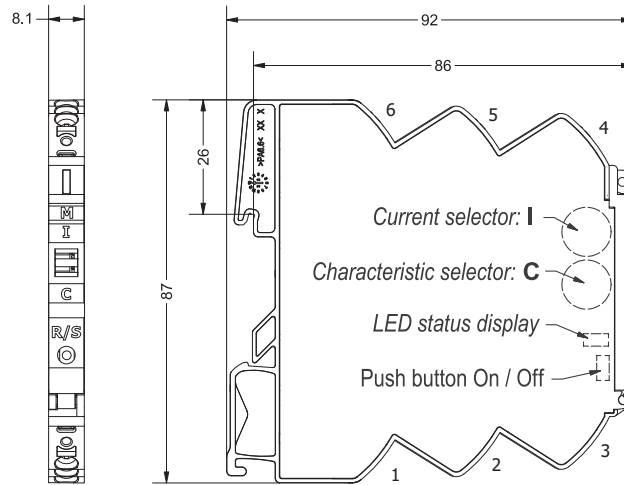

PIN assignment

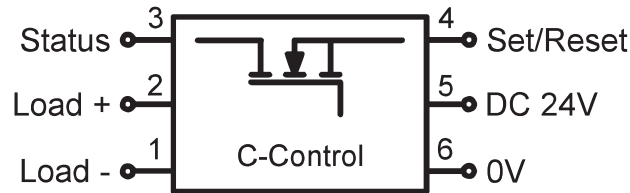

- 1: Load -
- 2: Load +
- 3: Status output
- 4: Set/Reset
- 5: DC +24V
- 6: 0V

1: Characteristic fast

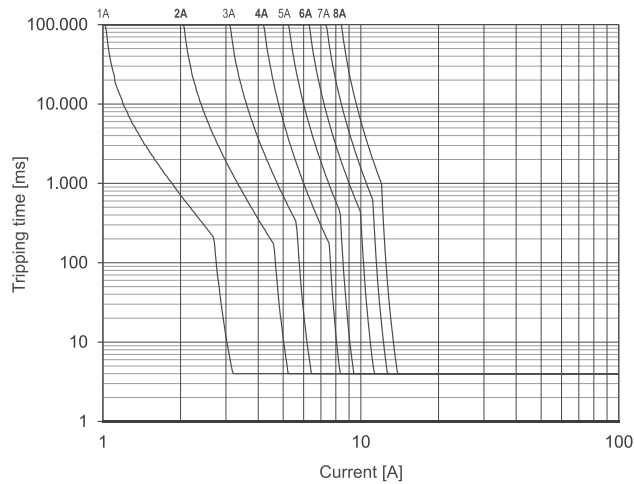

2: Characteristic medium

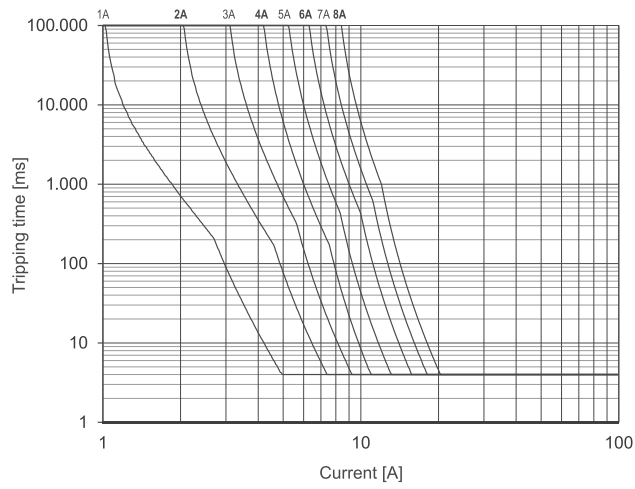

3: Characteristic slow-1

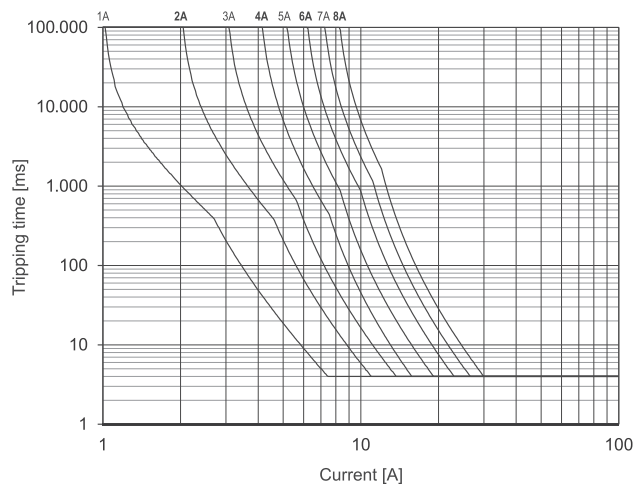

4: Characteristic slow-2

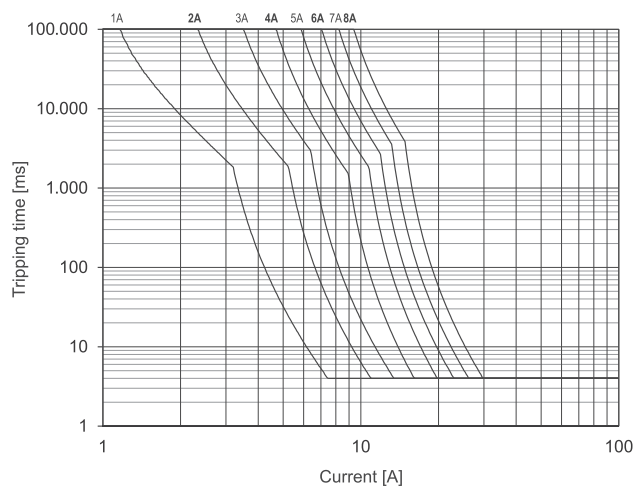

5: Characteristic slow-3

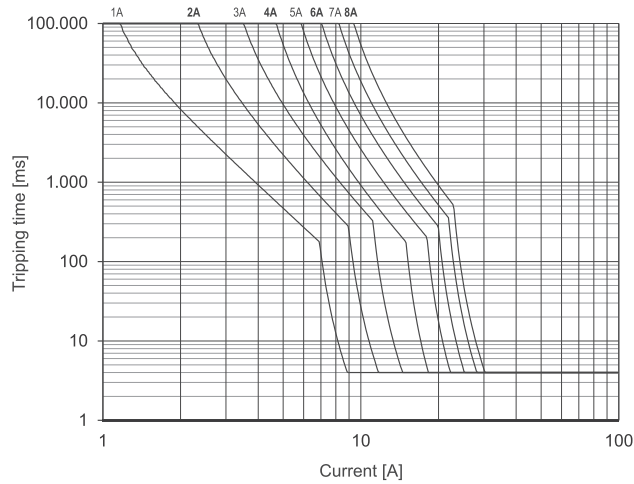

LED status

LED Status, Button, Rotary Switch

LED green	ON	Function is OK*
LED green, flashing 1 Hz	Overload	Load above 90 % of I nominal
LED green, flashing 5 Hz	Overload	Load above 100 % of I nominal
LED red	OFF	Module switched off or acknowledged*
LED red, flashing 1 Hz	Overload	Output off due to overload/short circuit*
LED red, flashing 5 Hz	Error	Wiring error – feedback (internal error)
LED red, flashing shortly	OFF	Output off via remote set/reset
LED red/green, flashing 1 Hz	ON	Target settings via rotary switch deviate from actual settings. NOTICE: Switching off and on via pushbutton required.
Button ***	ON/OFF	Nominal operation: ON/OFF Load monitoring tripped: 1st push: acknowledge 2nd push: ON
Rotary Switch (I) – Switch Position**		Rated current, see page 4.
Rotary Switch (C) – Switch Position**		Characteristic: 1: fast 2: middle 3: slow-1 4: slow-2 5: slow-3

* If the operating voltage is switched off, the last status is saved (Default).

** Accept the setting - after switching on again via the button, not by Remote Set/Reset

*** Master function - switch off via push button, can only be switched on again via push button

For further information see also the operating instructions

Signal output

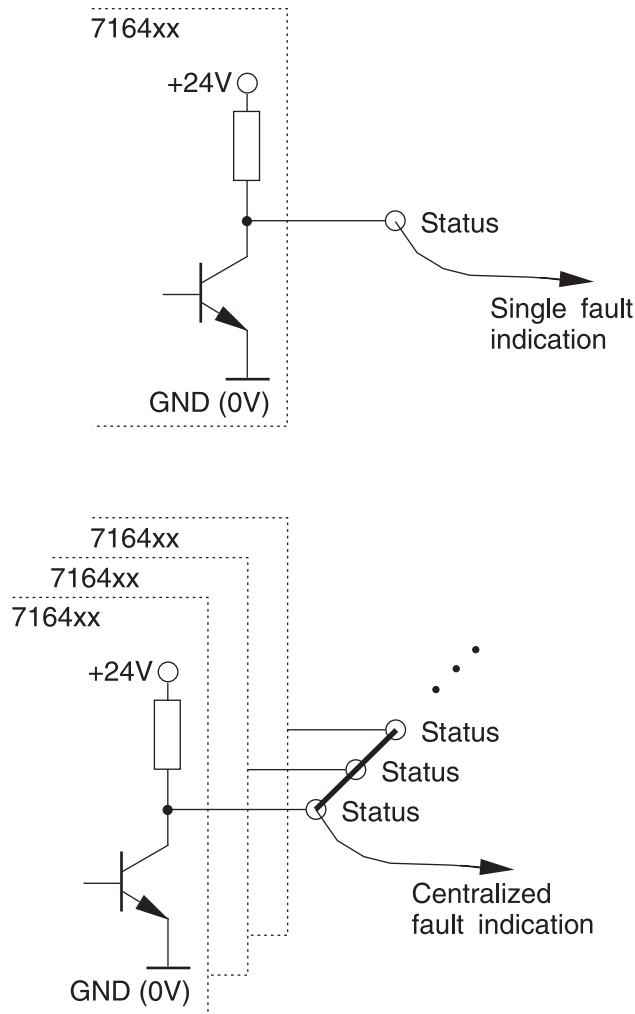

Mounting diagram

