

Safety Relays

ESM



EUCHNER

More than safety.



Headquarters in Leinfelden-Echterdingen



Logistics center in Leinfelden-Echterdingen



Production location in Unterböhringen

Internationally successful – the EUCHNER company

EUCHNER GmbH + Co. KG is a world-leading company in the area of industrial safety technology. EUCHNER has been developing and producing high-quality switching systems for mechanical and systems engineering for more than 50 years.

The medium-sized family-operated company based in Leinfelden, Germany, employs more than 500 people around the world, 400 in Germany alone.

In addition to the production locations in Unterböhringen and Shanghai/China, 14 subsidiaries and other sales partners in Germany and abroad work for our international success on the market.

Quality and innovation – the EUCHNER products

A look into the past shows EUCHNER to be a company with a great inventive spirit. We take the technological and ecological challenges of the future as an incentive for extraordinary product developments.

EUCHNER safety switches monitor safety doors on machines and installations, help to minimize dangers and risks and thereby reliably protect people and processes. Today, our products range from electromechanical and electronic components to intelligent integrated safety solutions. Safety for people, machines and products is one of our dominant themes.

We define future safety technology with the highest quality standards and reliable technology. Extraordinary solutions ensure the great satisfaction of our customers. The product ranges are subdivided as follows:

- ▶ Transponder-coded Safety Switches (CES)
- ▶ Transponder-coded Safety Switches with guard locking (CET)
- ▶ Interlocking and guard locking systems (Multifunctional Gate Box MGB)
- ▶ Access management systems (Electronic-Key-System EKS)
- ▶ Electromechanical Safety Switches
- ▶ Magnetically coded Safety Switches (CMS)
- ▶ Enabling Switches
- ▶ Safety Relays
- ▶ Emergency Stop Devices
- ▶ Hand-Held Pendant Stations and Handwheels
- ▶ Safety Switches with AS-Interface
- ▶ Joystick Switches
- ▶ Position Switches



Safety Relays ESM

General information	4
The ESM modular principle	4
Approvals	4
Explanation of symbols	4
Safety relays ESM	7
Safety relay ESM-BL.. and ESM-BA..	8
Safety relay time-delayed ESM-BT..	12
Safety relay 2-hand ESM-2H..	13
Contact expansion ESM-ES..	14
Contact expansion time-delayed ESM-TE..	15
Accessories	16
Technical data	17
Appendix	26
Glossary	26
Connection examples	26
Item index	29

General information

For machines and systems that can produce a risk for people when in operation, the EU Machinery directive defines minimum requirements that are intended to reduce to a minimum the specific hazards and the related risks of accident.

If all sources of danger cannot be eliminated by design measures, appropriate protective measures must be taken. Using safety guards, such as fences or similar, it is intended to prevent people entering the danger area. If users need to have access to the danger area during operation, movable safety guards such as safety doors, flaps, etc. are used. This is the case, for example, for loading or unloading, troubleshooting, machine setup or cleaning work.

To safeguard this access area, safety switches with various principles of operation are used. These switches are designed to monitor the position of the safety guard and, when the safety guard is opened, to generate a signal which will safely interrupt the supply of power to the potentially hazardous parts of the system or which will ensure that the safety circuits are safely interrupted. The EUCHNER safety relays series ESM ensure that the safety circuits are interrupted. On the one hand they safely evaluate components connected such as

- ▶ mechanical safety switches with and without guard locking,
- ▶ non-contact safety switches,
- ▶ emergency stop controls
- ▶ non-contact protective equipment, etc.

while on the other hand they safely shut down potentially hazardous machine functions.

The safety relays impress with their compact DIN rail housing and their suitability for applications up to safety category 4/PLe in accordance with EN ISO 13849-1.

The ESM modular principle

The majority of modules in the safety relay series ESM are installed in a housing that is only 22.5 mm wide. Various safety relays are available to which contact expansions can be added on the output side. The contact expansions can be non-time-delay or time-delayed. The advantage of this modular principle is that only a few devices are required to be able to realize a large number of different safety evaluations.

The relays can be operated with various types of starting. The devices can be started manually or automatically using suitable wiring. The manual start can also monitor the start button.

Using suitable wiring it is also possible to integrate a feedback loop such that safety-related parts of a machine or system downstream can also be monitored.



In the ESM series the majority of the devices are available with a variety of input voltage ranges.

Approvals

To demonstrate conformity, the Machinery Directive also includes the possibility of type examination. Although all relevant standards are taken into account during development, we have all our switchgear subjected to additional type examinations by a notified body.





Furthermore, numerous items of switchgear are listed by Underwriters Laboratories (UL). These items of switchgear can be used in countries in which this listing is required. The approval symbols on the individual pages of the catalog indicate which body tested the switchgear.

With the aid of the approval symbols listed below you can quickly see which approvals are available for the related switchgear:



	Switches with this symbol are approved by Underwriters Laboratories (UL)
	Switches with this symbol are approved by TÜV Rheinland

Explanation of symbols

Connection options

	Suitable for the connection of emergency stop
	Suitable for the connection of safety switches according to EN 1088
	Suitable for the connection of non-contact protective equipment, e. g. light curtains
	Suitable for the connection of 2-hand circuits

Fault detection

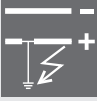
	Short circuit is detected
	Ground fault is detected
	Earth fault is detected



Time-delay

	Safety contacts switch time-delayed
---	-------------------------------------



Safety category

	Suitable up to category 3 according to EN ISO 13849-1
	Suitable up to category 4 according to EN ISO 13849-1

Stop category

	Immediate shutdown Stop category 0 according to EN 60204-1
	Time-delayed shutdown Stop category 1 according to EN 60204-1

Technical data

	Mechanical data
	Electrical data

Selection table for safety relays ESM

Safety relays																	
BL	Non-time-delay category 3																
BA	Non-time-delay category 4																
BT	Time-delay category 3/non-time delay category 4																
2H	2-hand requirement level IIC according to EN 574, category 4																
Contact expansion																	
ES	Non-time-delay category 4																
TE	Time-delay category 4																
Category according to EN ISO 13849-1																	
K	Category according to EN ISO 13849-1																
Enable path																	
SU	Safety contacts non-time-delay																
SV	Safety contacts time-delay																
M	Monitored Start button																
Relay start																	
A	Automatic start																
M	Start button																
U	Monitored Start button																
Monitoring																	
R	Feedback loop																
Q	Short circuit monitoring																
E	Earth fault monitoring																
M	Ground fault monitoring																
BL	BA	BT	2H	ES	TE	K	SU	SV	M	A	M	U	R	Q	E	M	Page
●						3	2			●	●		●				8
	●					4	2			●	●	●	●	●	●	●	9
	●					4	3		1	●	●	●	●	●	●	●	10
	●					4	7		4	●	●	●	●	●	●	●	11
		●				4/3	1	3		●	●	●	●	●	●	●	12
		●				4/3	2	2		●	●	●	●	●	●	●	12
		●				4/3	3	1		●	●	●	●	●	●	●	12
			●			4	2					●	●	●	●	●	13
				●		4	3		1						●	●	14
					●	3		3	1						●	●	15

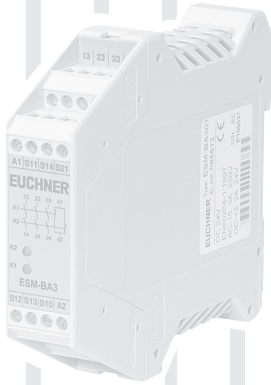

Safety relays ESM-BL.. and ESM-BA..



- ▶ ESM-BL.. Usage up to category 3 according to EN ISO 13849-1
- ▶ ESM-BA.. Usage up to category 4 according to EN ISO 13849-1
- ▶ LED status indicators
- ▶ 1-channel or 2-channel control
- ▶ Up to 7 redundant safety contacts
- ▶ Auxiliary contact (signaling contact) optional
- ▶ Short circuit and earth fault/ground fault monitoring optional

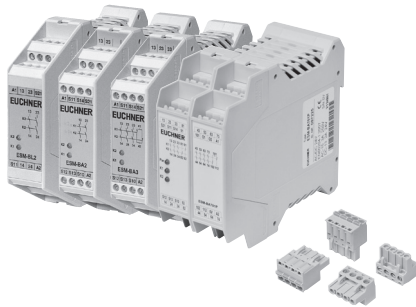

Relay outputs

The outputs are electrically decoupled and of redundant design.

Connection options

By using suitable wiring the following functions can be selected:

- ▶ Relay start with automatic start or a start button
- ▶ Monitoring of downstream relays or contactors

On the series **ESM-BA..** safety relays, by using suitable wiring it is also possible to select:

- ▶ Simultaneity monitoring to monitor safety components over time
- ▶ Short circuit monitoring to detect short circuits between the connection cables and to shut down the outputs or prevent relay starting if necessary
- ▶ Earth fault/ground fault monitoring to detect short circuits between the connection cables and earth or ground and to shut down the outputs or prevent relay starting if necessary.

Auxiliary contacts

The relays in the series ESM-BA3.. and ESM-BA7... are available with electrically separate normally closed contacts and auxiliary contacts.

Connection terminals

Optionally the ESM-BA... devices are also available as version with plug-in connection terminals.

Safety relay ESM-BL..



Cat. 3 STOP 0

Dimension drawing

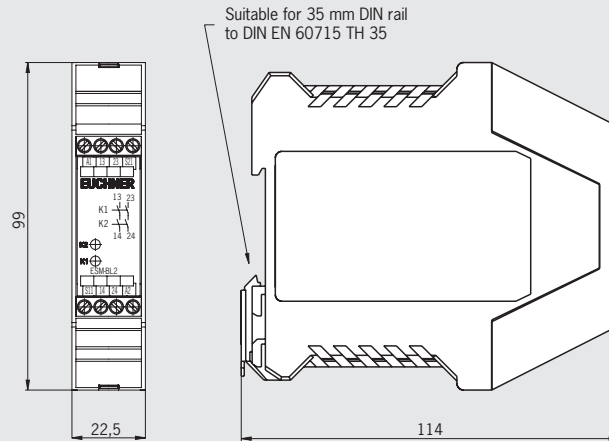

Block diagram

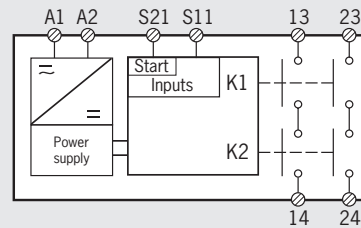

Technical data outputs

Parameter	Value		
Min. switching current at DC 24 V	20 mA		
Switching voltage max.	DC 24 V / AC 250 V		
Utilization category * According to EN 60947-5-1	U_o	I_o	ΣI_o
	AC-12	250 V	6 A
	AC-15	230 V	4 A
	DC-12	24 V	1.25 A
	DC-13	24 V	2 A

U_o = switching voltage

I_o = max. switching current per contact

ΣI_o = max. switching current on all safety contacts (cumulative current)

* See page 26 for information about the utilization category

Ordering table

Series	Version	Outputs	AC/DC 24 V	AC 115 V	AC 230 V
ESM	BL Safety relay	2 2 NO	085607 ESM-BL201	085608 ESM-BL202	085609 ESM-BL203



Safety relay ESM-BA2..



Cat. 4 STOP 0

Dimension drawing

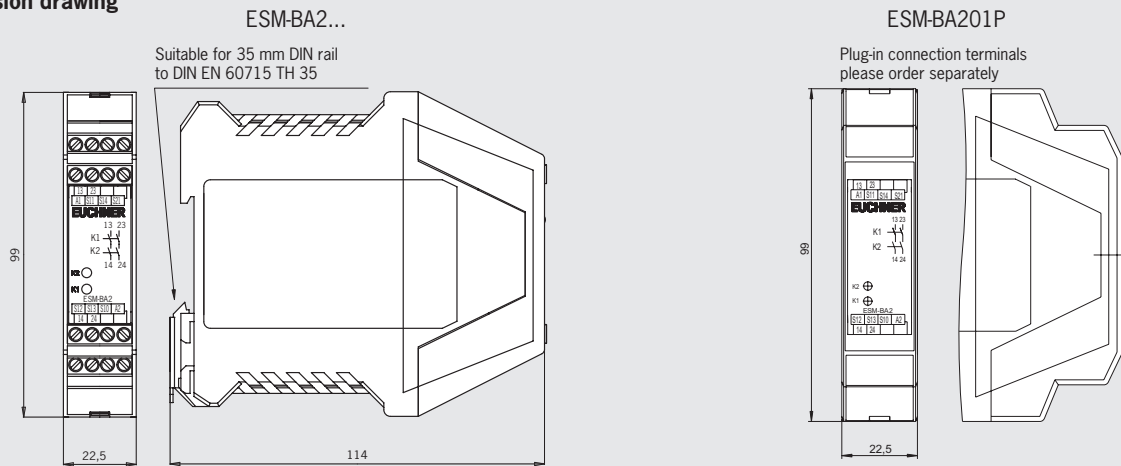

Block diagram

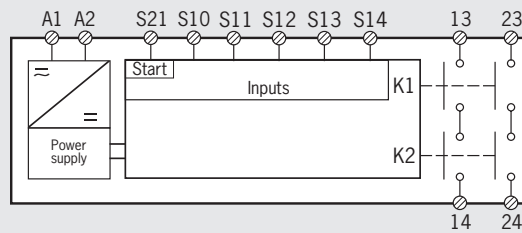

Technical data outputs

Parameter	Value		
Min. switching current at DC 24 V	20 mA		
Switching voltage max.	DC 24 V / AC 250 V		
Utilization category * According to EN 60947-5-1	U_e	I_e	ΣI_e
	AC-12	250 V	6 A
	AC-15	230 V	4 A
	DC-12	24 V	1.25 A
	DC-13	24 V	2 A
			12 A

U_e = switching voltage

I_e = max. switching current per contact

ΣI_e = max. switching current on all safety contacts (cumulative current)

* See page 26 for information about the utilization category

Ordering table

Series	Version	Outputs	Version	AC/DC 24 V	AC 115 V	AC 230 V
ESM	BA Safety relay	2 2 NO	Screw terminals	085610 ESM-BA201	085611 ESM-BA202	085612 ESM-BA203
			Plug-in connection terminals ¹⁾	097226 ESM-BA201P	-	-

1) Please order plug-in connection terminals separately (see page 16)



Safety relay ESM-BA3..



Cat. 4 STOP 0

Dimension drawing

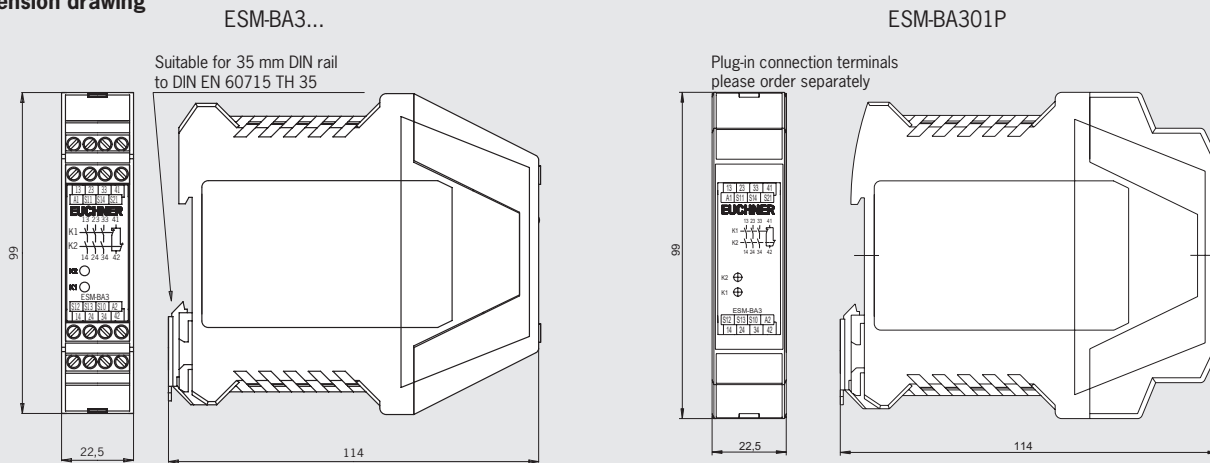

Block diagram

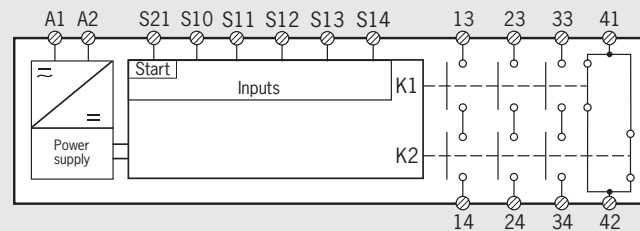

Technical data outputs

Parameter	Value		
Min. switching current at DC 24 V	5 mA		
Switching voltage max.	DC 24 V / AC 250 V		
Utilization category * According to EN 60947-5-1	U_e	I_e	ΣI_e
	AC-12	250 V	8 A
	AC-15	250 V	3 A
	DC-12	50 V	8 A
	DC-13	24 V	3 A
			15 A ¹⁾

1) If several ESM-BA3.. are closely spaced under load, the max. cumulative current at an ambient temperature of 20 °C = 9 A; at 30 °C = 3 A; at 40 °C = 1 A. If these currents are exceeded, a spacing of 5 mm between the devices must be observed.

U_e = switching voltage

I_e = max. switching current per contact

ΣI_e = max. switching current on all safety contacts (cumulative current)

* See page 26 for information about the utilization category

Ordering table

Series	Version	Outputs	Version	AC/DC 24 V	AC 115 V	AC 230 V
ESM	BA Safety relay	3 3 NO + 1 NC	Screw terminals	085613 ESM-BA301	087412 ESM-BA302	087413 ESM-BA303
			Plug-in connection terminals ¹⁾	097230 ESM-BA301P	-	-

1) Please order plug-in connection terminals separately (see page 16)



Safety relay ESM-BA7..



Cat. 4 STOP 0

Dimension drawing

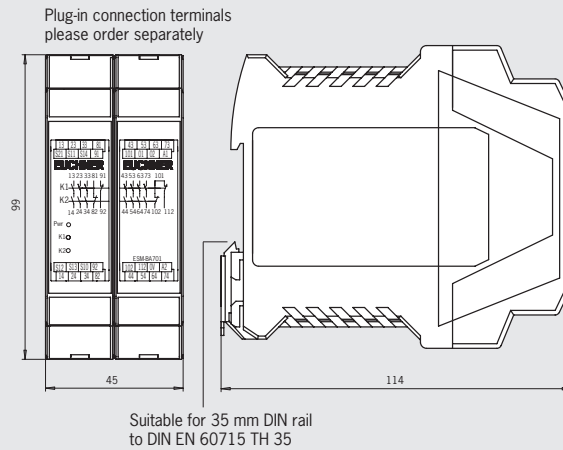

Block diagram

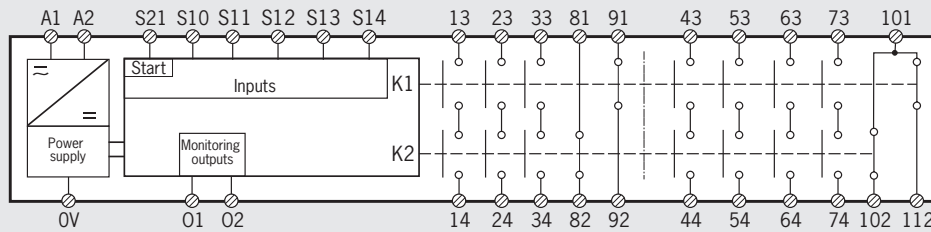

Technical data outputs

Parameter	Value			
Min. switching current at DC 24 V	5 mA			
Switching voltage max.	DC 50 V / AC 250 V			
Utilization category * According to EN 60947-5-1		U_e	I_e	Σ I_e
	AC-12	250 V	8 A	
	AC-15	250 V	3 A	
	DC-12	50 V	8 A	
	DC-13	24 V	3 A	35 A ¹⁾

1) With a housing distance of 10 mm. 20 A closely spaced at 40 °C

U_e = switching voltage

I_e = max. switching current per contact

Σ I_e = max. switching current on all safety contacts (cumulative current)

* See page 26 for information about the utilization category

Ordering table

Series	Version	Outputs	Version	AC/DC 24 V	AC 115 V	AC 230 V
ESM	BA Safety relay	7 7 NO + 4 NC	Plug-in connection terminals ¹⁾	097225 ESM-BA701P	-	-

1) Please order plug-in connection terminals separately (see page 16). Two connection kits are required for devices from series ESM-BA701P.

Safety relays ESM-BT..



- ▶ Usage up to category 4 according to EN ISO 13849-1
- ▶ LED status indicators
- ▶ 1-channel or 2-channel control
- ▶ 4 redundant safety contacts of which 1, 2 or 3 contacts time-delayed
- ▶ Time-delay range between 1 s and 30 s
- ▶ Short circuit and earth fault/ground fault monitoring



Relay outputs

The outputs are electrically decoupled and of redundant design.

Connection options

By using suitable wiring the following functions can be selected:

- ▶ Relay start with automatic start, a start button or a monitored start button
- ▶ Monitoring of downstream relays or contactors
- ▶ Simultaneity monitoring to monitor safety components over time
- ▶ Short circuit monitoring to detect short circuits between the connection cables and to shut down the outputs or prevent relay starting if necessary
- ▶ Earth fault/ground fault monitoring to detect short circuits between the connection cables and earth or ground and to shut down the outputs or prevent relay starting if necessary.

Time-delayed shutdown

The release time for the time-delay contacts can be set as required using a potentiometer on the safety relay.

Safety relay ESM-BT..



Dimension drawing

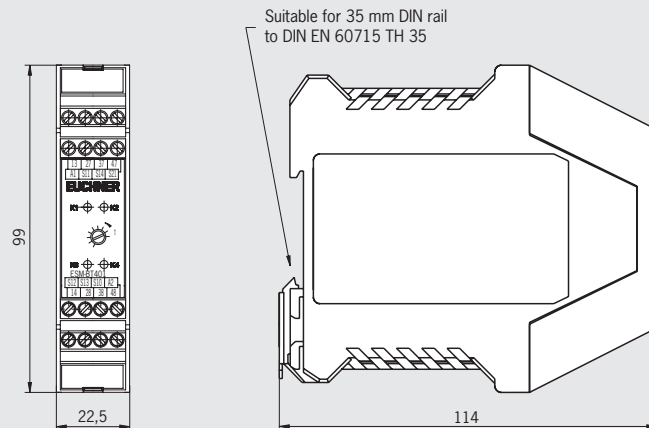

Block diagram

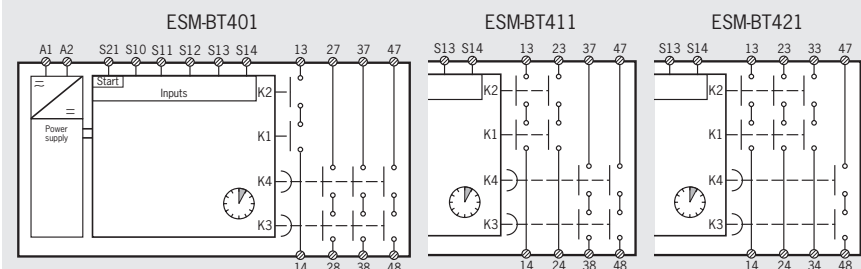

Technical data outputs

Parameter	Value			
Min. switching current at DC 24 V	5 mA			
Switching voltage max.	DC 50 V / AC 250 V			
Utilization category * According to EN 60947-5-1	U_e	I_e	Σ I_e	
	AC-12	250 V		8 A
	AC-15	250 V		3 A
	DC-12	50 V		8 A
	DC-13	24 V		3 A

U_e = switching voltage

I_e = max. switching current per contact

Σ I_e = max. switching current on all safety contacts (cumulative current)

* See page 26 for information about the utilization category

Ordering table

Series	Version	Outputs	AC/DC 24 V
ESM	BT Safety relay	401 1 NO non-time-delay 3 NO time-delay	090818 ESM-BT401
		411 2 NO non-time-delay 2 NO time-delay	090819 ESM-BT411
		421 3 NO non-time-delay 1 NO time-delay	090820 ESM-BT421

Safety relays ESM-2H..



- ▶ Usage up to category 4 according to EN ISO 13849-1
- ▶ Requirement level III C according to EN 574
- ▶ LED status indicators
- ▶ Operation using 2-hand control
- ▶ 2 redundant safety contacts
- ▶ Short-circuit and earth fault/ground fault monitoring can be selected

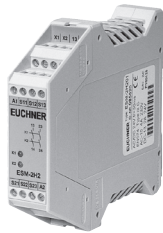

Relay outputs

The outputs are electrically decoupled and of redundant design.

Connection

- ▶ Two buttons each with one normally closed contact and one normally open contact that are monitored for simultaneity according to EN 574. In this way a high level of protection against tampering is provided.
- ▶ Short circuit monitoring to detect short circuits between the connection cables and to shut down the outputs or prevent relay starting if necessary.
- ▶ Earth fault/ground fault monitoring to detect short circuits between the connection cables and earth or ground and to shut down the outputs or prevent relay starting if necessary.

Connection option

By using suitable wiring the following function can be selected:

- ▶ Monitoring of downstream relays or contactors

Safety relay ESM-2H..



Cat. 4 STOP 0

Dimension drawing

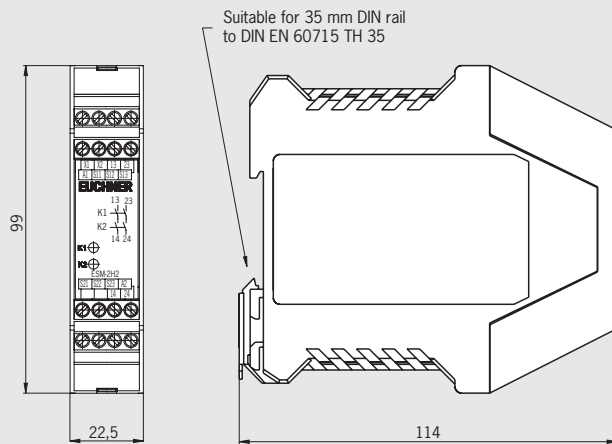

Block diagram

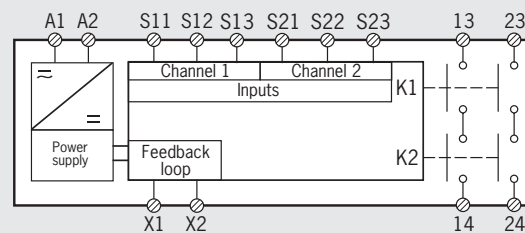

Technical data outputs

Parameter	Value			
Min. switching current at DC 24 V	20 mA			
Switching voltage max.	DC 24 V / AC 250 V			
Utilization category * According to EN 60947-5-1	U_e	I_e	Σ I_e	
	AC-12	250 V	6 A	8.4 A
	AC-15	230 V	4 A	
	DC-12	24 V	1.25 A	
DC-13	24 V	2 A		

U_e = switching voltage

I_e = max. switching current per contact

Σ I_e = max. switching current on all safety contacts (cumulative current)

* See page 26 for information about the utilization category

Ordering table

Series	Version	Outputs	AC/DC 24 V	AC 115 V	AC 230 V
ESM	2H Safety relay	2 2 NO	085620 ESM-2H201	098345 ESM-2H202	-

For technical data see page 17

Contact expansion ESM-ES..



- ▶ Usage up to category 4 according to EN ISO 13849-1
- ▶ LED status indicators
- ▶ Control using safety relays
- ▶ 3 redundant safety contacts
- ▶ 1 door auxiliary contact
- ▶ Earth fault/ground fault monitoring can be selected

Contact expansion ESM-ES..



Cat. 4 STOP 0

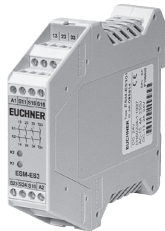

Relay outputs

The outputs are electrically decoupled and of redundant design.

Connection option

By using suitable wiring the following function can be selected:

- ▶ Earth fault/ground fault monitoring to detect short circuits between the connection cables and earth or ground and to shut down the outputs or prevent relay starting if necessary.

Dimension drawing

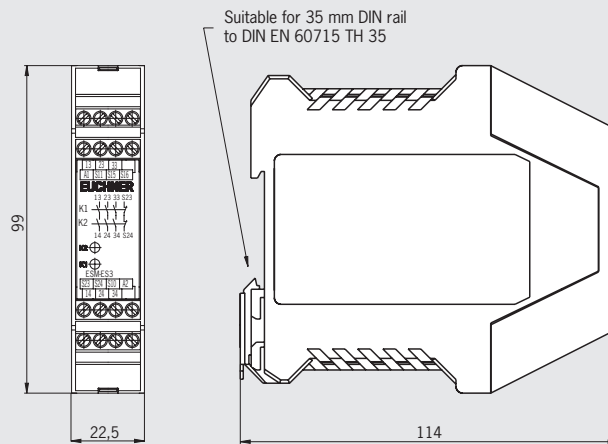

Block diagram

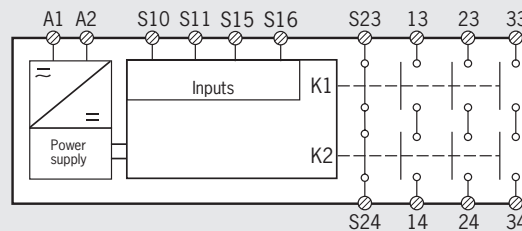

Technical data outputs

Parameter	Value			
Min. switching current at DC 24 V	5 mA			
Switching voltage max.	DC 50 V / AC 250 V			
Utilization category * According to EN 60947-5-1	U_e	I_e	Σ I_e	
	AC-12	250 V		6 A
	AC-15	230 V		4 A
	DC-12	24 V		1.25 A
	DC-13	24 V	2 A	10.5 A

U_e = switching voltage

I_e = max. switching current per contact

Σ I_e = max. switching current on all safety contacts (cumulative current)

* See page 26 for information about the utilization category

Ordering table

Series	Version	Outputs	AC/DC 24 V	AC 115 V	AC 230 V
ESM	ES Contact expansion	3 3 NO + 1 NC	085614 ESM-ES301	085615 ESM-ES302	085616 ESM-ES303



Contact expansion ESM-ES..

- ▶ Usage up to category 3 according to EN ISO 13849-1
- ▶ LED status indicators
- ▶ Control using safety relays
- ▶ 3 redundant time-delayed safety contacts
- ▶ Time-delay range between 1 s and 30 s
- ▶ Fixed time delay of 0.5 s optional
- ▶ 1 auxiliary contact
- ▶ Earth fault/ground fault monitoring can be selected

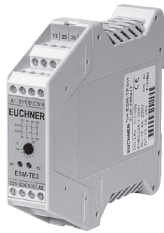

Relay outputs

The outputs are electrically decoupled and of redundant design.

Connection option

By using suitable wiring the following function can be selected:

- ▶ Earth fault/ground fault monitoring to detect short circuits between the connection cables and earth or ground and to shut down the outputs or prevent relay starting if necessary.

Time-delayed shutdown

The release time for the time-delay contacts can be set as required using a potentiometer on the safety relay.

Contact expansion ESM-ES..



Cat. 3 STOP 1

Dimension drawing

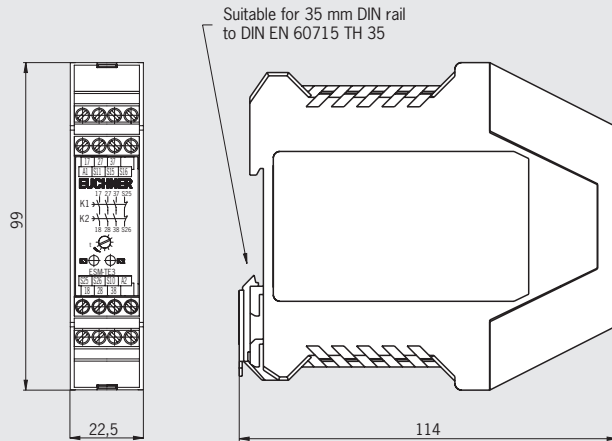

Block diagram

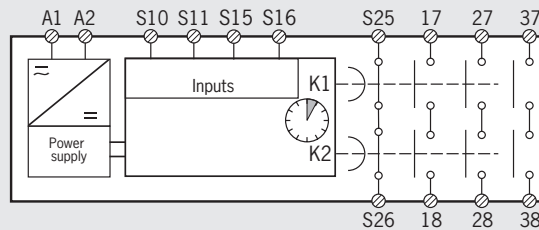

Technical data outputs

Parameter	Value			
Min. switching current at DC 24 V	5 mA			
Switching voltage max.	DC 50 V / AC 250 V			
Utilization category * According to EN 60947-5-1	U_e	I_e	Σ I_e	
	AC-12	250 V		6 A
	AC-15	250 V		4 A
	DC-12	24 V		1.25 A
	DC-13	24 V	2 A	10.5 A

U_e = switching voltage

I_e = max. switching current per contact

Σ I_e = max. switching current on all safety contacts (cumulative current)

* See page 26 for information about the utilization category

Ordering table

Series	Version	Outputs	Time-delay	AC/DC 24 V	AC 115 V	AC 230 V
ESM	TE Contact expansion	3 NO + 1 NC time-delayed	Adjustable 1 s ... 30 s	085617 ESM-TE301	085618 ESM-TE302	085619 ESM-TE303
			Fixed 0.5 s	097223 ESM-TE301-05S	-	-

Accessories for Safety System ESM

- ▶ Connection kit ESM...P with screw terminals or spring terminals

Important: One connection kit is required, depending on the device (see information on the corresponding product page). Two connection kits are required for devices from series ESM-BA701P.

Ordering table

Designation	Description	Order No.
Connection kit ESM...P with screw terminals	Comprising: 4 plug-in screw terminals (can be coded) 2 jumpers coding pins	097194 ESM-F-AK4
Connection kit ESM...P with spring terminals	Comprising: 4 plug-in spring terminals (can be coded) 2 jumpers coding pins	097195 ESM-F-KK4

Overview safety relays ESM

Safety relay ESM						Page
BL	BA	BT	2H	ES	TE	
●						18
	●					19
		●				22
			●			23
				●		24
					●	25

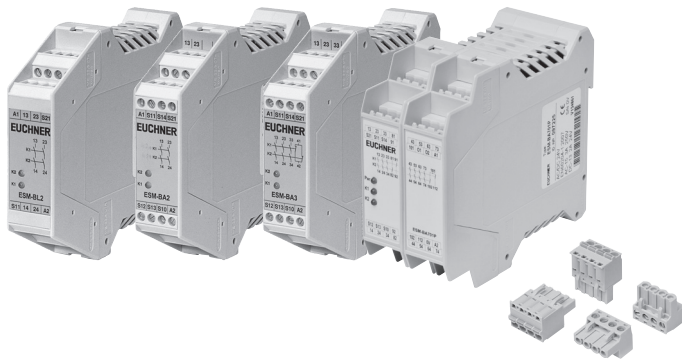

Housing						
Parameter	Value					Unit
Housing material	Polyamide PA6.6					
Dimensions	114 x 99 x 22.5 (ESM-BA7... 114 x 99 x 45)					mm
Weight	Approx. 0.25 (ESM-BA7... approx. 0.35)					kg
Connection	Connection terminals					
Connection terminals	0.14 ... 2.5					mm ²
Ambient temperature	Base	ESM-BL2.. ESM-BA2..	ESM-BA3.. ESM-BA7..	ESM-BT4..	ESM-2H2..	
	at U _B = 24 V DC	-15 ... +60	-15 ... +40	-15 ... +40	-15 ... +60	°C
	at U _B = 115/230 V AC	-15 ... +40	-15 ... +40	-	-15 ... +40	°C
	Contact expansion	ESM-ES3.. ESM-TE3...				
	at U _B = 24 V DC	-15 ... +60				°C
	at U _B = 115/230 V AC	-15 ... +40				°C
Degree of protection according to EN 60529	IP 20					
Degree of contamination	2					
Mounting	DIN rail 35 mm according to DIN EN 60715 TH 35					
Life	Base	ESM-BL2.. ESM-BA2.. ESM-BA3..	ESM-BA7..	ESM-BT4..	ESM-2H2..	
	Mechanical	1 x 10 ⁷	1 x 10 ⁶	1 x 10 ⁶	1 x 10 ⁷	operating cycles
	Electrical	1 x 10 ⁵	1 x 10 ⁶	1 x 10 ⁵	1 x 10 ⁵	operating cycles
	Contact expansion	ESM-ES3.. ESM-TE3...				
	Mechanical	1 x 10 ⁷				operating cycles
	Electrical	1 x 10 ⁵				operating cycles

Connection ESM-BL2..						
Parameter	Value					Unit
Operating voltage	ESM-BL201	24 ± 10% ¹⁾				V AC/DC
	ESM-BL202	115 ± 10%				V AC
	ESM-BL203	230 ± 10%				V AC
Reverse polarity protection	On ESM-BL201					
Rated supply frequency	50 ... 60					Hz
Power consumption	Approx. 3 VA / 1.8 W					
Control voltage for start button	18.6 ... 26					V DC
Control cable length (cross-section 0.75 mm ²)	Max. 1000					m
Control current for start button	Approx. 40					mA
External contact fuse (safety circuit) acc. to EN IEC 60269-1	10 A gG (T4A / F6A)					
Test voltage (control voltage/contacts)	2.5					kV
Rated impulse withstand voltage, Leakage path and air gaps acc. to DIN VDE 0110-1	4					kV
Rated insulation voltage	250					V
Over voltage category according to DIN VDE 0110-1	3					
Safety contacts	2 NO contacts (redundant)					
Min. switching current at 24 V DC	20					mA
Switching voltage max.	24					V DC
	250					V AC
Breaking capacity acc. to Ⓢ	6 A 250 V AC					
	2 A 24 V DC					
Utilization category ²⁾	U_e		I_e		Σ I_e	
According to EN 60947-5-1	AC-12	250 V		6 A	12 A	
	AC-15	230 V		4 A		
	DC-12	24 V		1.25 A		
	DC-13	24 V		2 A		
LED indicators	2, status display for relays K1 and K2					
Reliability values acc. to EN ISO 13849-1						
Category	3					
Performance Level PL	d					

1) All the electrical connections must either be isolated from the mains supply by a safety transformer according to EN 61558-2-6 with limited output voltage in the event of a fault, or by other equivalent isolation measures.

2) See page 26 for information about the utilization category.

U_e = switching voltage

I_e = max. switching current per contact

Σ I_e = max. switching current on all safety contacts (cumulative current)

Connection ESM-BA2..			
Parameter		Value	Unit
Operating voltage	ESM-BA201	24 ± 10% ¹⁾	V AC/DC
	ESM-BA202	115 ± 10%	V AC
	ESM-BA203	230 ± 10%	V AC
Reverse polarity protection		On ESM-BA201	
Rated supply frequency		50 ... 60	Hz
Power consumption		Approx. 3 VA / 1.8 W	
Control voltage for start button		18.6 ... 26	V DC
Control cable length (cross-section 0.75 mm ²)		Max. 1000	m
Control current for start button		Approx. 40	mA
External contact fuse (safety circuit) acc. to EN IEC 60269-1		10 A gG (T4A / F6A)	
Test voltage (control voltage/contacts)		2.5	kV
Rated impulse withstand voltage, Leakage path and air gaps acc. to DIN VDE 0110-1		4	kV
Rated insulation voltage		250	V
Over voltage category according to DIN VDE 0110-1		3	
Safety contacts		2 NO contacts (redundant)	
Min. switching current at 24 V DC		20	mA
Switching voltage max.		24	V DC
		250	V AC
Breaking capacity acc. to \mathcal{U}		6 A 250 V AC 2 A 24 V DC	
Utilization category ²⁾		U_e	I_e
According to EN 60947-5-1	AC-12	250 V	6 A
	AC-15	230 V	4 A
	DC-12	24 V	1.25 A
	DC-13	24 V	2 A
			Σ I_e
			12 A
LED indicators		2, status display for relays K1 and K2	
Reliability values acc. to EN ISO 13849-1			
Category		4	
Performance Level PL		e	

1) All the electrical connections must either be isolated from the mains supply by a safety transformer according to EN 61558-2-6 with limited output voltage in the event of a fault, or by other equivalent isolation measures.

2) See page 26 for information about the utilization category.

U_e = switching voltage

I_e = max. switching current per contact

Σ I_e = max. switching current on all safety contacts (cumulative current)

Connection ESM-BA3..



Parameter		Value	Unit
Operating voltage	ESM-BA301	24 ± 10% ¹⁾	V AC/DC
	ESM-BA302	115 ± 10%	V AC
	ESM-BA303	230 ± 10%	V AC
Reverse polarity protection		On ESM-BA301	
Rated supply frequency		50 ... 60	Hz
Power consumption		Approx. 7	VA
Control voltage for start button		18.6 ... 26	V DC
Control cable length (cross-section 0.75 mm ²)		Max. 1000	m
Control current for start button		Approx. 60	mA
External contact fuse (safety circuit) acc. to EN IEC 60269-1		10 A gG (T6A / F8A)	
Test voltage (control voltage/contacts)		2.5	kV
Rated impulse withstand voltage, Leakage path and air gaps acc. to DIN VDE 0110-1		4	kV
Rated insulation voltage		250	V
Over voltage category according to DIN VDE 0110-1		3	
Safety contacts		3 NO contacts (redundant)	
Cumulative current on all contacts acc. to \mathcal{U}		Max. 15	A
Min. switching current at 24 V DC		5	mA
Switching voltage max.		50	V DC
		250	V AC
Breaking capacity acc. to \mathcal{U}	ESM-BA301	8 A 250 V AC / 2 A 24 V DC	
	ESM-BA302		
	ESM-BA303	8 A 250 V AC / 3 A 24 V DC	
Utilization category ²⁾ According to EN 60947-5-1		U_e	I_e
	AC-12	250 V	8 A ⁴⁾
	AC-15	250 V	3 A
	DC-12	50 V	8 A ⁴⁾
	DC-13	24 V	3 A
			ΣI_e
			15 A ³⁾
LED indicators		2, status display for relays K1 and K2	
Signaling contact		1 NC contact	
Switching voltage max.		24	V DC
		250	V AC
Breaking capacity acc. to \mathcal{U}	ESM-BA301	2 A 250 V AC / 1.5 A 24 V DC	
	ESM-BA302		
	ESM-BA303	2 A 250 V AC / 2 A 24 V DC	
Utilization category ²⁾ According to EN 60947-5-1		U_e	I_e
	AC-12	250 V	2 A
	AC-15	250 V	1.5 A
	DC-12	50 V	2 A
	DC-13	24 V	1.25 A
Reliability values acc. to EN ISO 13849-1			
Category		4	
Performance Level PL		e	

1) All the electrical connections must either be isolated from the mains supply by a safety transformer according to EN 61558-2-6 with limited output voltage in the event of a fault, or by other equivalent isolation measures.

2) See page 26 for information about the utilization category.

3) If several ESM-BA3.. are closely spaced under load, the max. cumulative current at an ambient temperature of 20 °C = 9 A; at 30 °C = 3 A; at 40 °C = 1 A. If these currents are exceeded, a spacing of 5 mm between the devices must be observed.

4) With Ohmic load.

U_e = switching voltage

I_e = max. switching current per contact

ΣI_e = max. switching current on all safety contacts (cumulative current)

Connection ESM-BA7.. 				
Parameter	Value		Unit	
Operating voltage	24 ± 10% ¹⁾		V AC/DC	
Reverse polarity protection	Yes			
Rated supply frequency	50 ... 60		Hz	
Power consumption	Approx. 7		VA	
Control voltage for start button	18.6 ... 26		V DC	
Control cable length (cross-section 0.75 mm ²)	Max. 1000		m	
Control current for start button	Approx. 100		mA	
External contact fuse (safety circuit) acc. to EN IEC 60269-1	10 A gG (T6A / F8A)			
Test voltage (control voltage/contacts)	2.5		kV	
Rated impulse withstand voltage, Leakage path and air gaps acc. to DIN VDE 0110-1	4		kV	
Rated insulation voltage	250		V	
Over voltage category according to DIN VDE 0110-1	3			
Safety contacts	7 NO contacts (redundant)			
Min. switching current at 24 V DC	5		mA	
Switching voltage max.	50		V DC	
	250		V AC	
Breaking capacity acc. to \mathcal{U} (per contact)	8 A 250 V AC			
	2 A 24 V DC			
Utilization category ²⁾ According to EN 60947-5-1	U_e	I_e	Σ I_e	
	AC-12	250 V	8 A	35 A ³⁾
	AC-15	250 V	3 A	
	DC-12	50 V	8 A	
	DC-13	24 V	3 A	
LED indicators	2, status display for relays K1 and K2			
Auxiliary contacts	4 NC contacts			
Switching voltage max.	50		V DC	
	250		V AC	
Breaking capacity acc. to \mathcal{U}	2 A 250 V AC 1.5 A 24 V DC			
Utilization category ²⁾ According to EN 60947-5-1	U_e	I_e		
	AC-12	250 V	8 A	
	AC-15	250 V	3 A	
	DC-12	50 V	8 A	
	DC-13	24 V	3 A	
Door monitoring outputs	2 semiconductor outputs			
Semiconductor output current	Max. 30		mA	
Semiconductor output voltage	24		V DC	
Reliability values acc. to EN ISO 13849-1				
Category	4			
Performance Level PL	e			

1) All the electrical connections must either be isolated from the mains supply by a safety transformer according to EN 61558-2-6 with limited output voltage in the event of a fault, or by other equivalent isolation measures.

2) See page 26 for information about the utilization category.

3) With a housing distance of 10 mm. 20 A closely spaced at 40 °C.

U_e = switching voltage I_e = max. switching current per contact

Σ I_e = max. switching current on all safety contacts (cumulative current)



Connection ESM-BT4..



Parameter	Value	Unit																	
Operating voltage	24 ± 10% ¹⁾	V AC/DC																	
Reverse polarity protection	Yes																		
Rated supply frequency	50 ... 60	Hz																	
Power consumption	Approx. 4.6	W																	
Time-delay range	1 ... 30	s																	
Control voltage for start button	18.6 ... 26	V DC																	
Control cable length (cross-section 0.75 mm ²)	Max. 1000	m																	
Control current for start button	Approx. 190	mA																	
External contact fuse (safety circuit) acc. to EN IEC 60269-1	10 A gG (T6A / F8A)																		
Test voltage (control voltage/contacts)	2.5	kV																	
Rated impulse withstand voltage, Leakage path and air gaps acc. to DIN VDE 0110-1	4	kV																	
Rated insulation voltage	250	V																	
Over voltage category according to DIN VDE 0110-1	3																		
Safety contacts	4 NO contacts (redundant)																		
Cumulative current on all contacts acc. to $\text{\textcircled{U}}$	Max. 15	A																	
Min. switching current at 24 V DC	5	mA																	
Switching voltage max.	50	V DC																	
	250	V AC																	
Breaking capacity acc. to $\text{\textcircled{U}}$ (per contact)	6 A 250 V AC 2 A 24 V DC																		
Utilization category ²⁾ According to EN 60947-5-1	<table border="1"> <thead> <tr> <th></th> <th>U_e</th> <th>I_e</th> <th>ΣI_e</th> </tr> </thead> <tbody> <tr> <td>AC-12</td> <td>250 V</td> <td>8 A ⁴⁾</td> <td rowspan="4">15 A ³⁾</td> </tr> <tr> <td>AC-15</td> <td>250 V</td> <td>3 A</td> </tr> <tr> <td>DC-12</td> <td>50 V</td> <td>8 A ⁴⁾</td> </tr> <tr> <td>DC-13</td> <td>24 V</td> <td>3 A</td> </tr> </tbody> </table>		U_e	I_e	ΣI_e	AC-12	250 V	8 A ⁴⁾	15 A ³⁾	AC-15	250 V	3 A	DC-12	50 V	8 A ⁴⁾	DC-13	24 V	3 A	
	U_e	I_e	ΣI_e																
AC-12	250 V	8 A ⁴⁾	15 A ³⁾																
AC-15	250 V	3 A																	
DC-12	50 V	8 A ⁴⁾																	
DC-13	24 V	3 A																	
LED indicators	4, status display for relays K1 to K4																		
Reliability values acc. to EN ISO 13849-1																			
Category	4 (non-time-delayed) / 3 (time-delayed)																		
Performance Level PL	e																		

1) All the electrical connections must either be isolated from the mains supply by a safety transformer according to EN 61558-2-6 with limited output voltage in the event of a fault, or by other equivalent isolation measures.

2) See page 26 for information about the utilization category.

3) With a housing distance of 5 mm. 9 A closely spaced at 40 °C.

4) With Ohmic load.

U_e = switching voltage

I_e = max. switching current per contact

ΣI_e = max. switching current on all safety contacts (cumulative current)

Connection ESM-2H2..



Parameter	Value		Unit
Operating voltage	ESM-2H201	24 ± 10% ¹⁾	V AC/DC
	ESM-2H202	115 ± 10%	V AC
Reverse polarity protection	On ESM-2H201		
Rated supply frequency	50 ... 60		Hz
Power consumption	Approx. 4		VA
Control voltage on start buttons S12 - S13 and S22 - S23	18.6 ... 26		V DC
Control cable length (cross-section 0.75 mm ²)	Max. 1000		m
Control current for both buttons	Each 20		mA
External contact fuse (safety circuit) acc. to EN IEC 60269-1	10 A gG (T4A / F6A)		
Test voltage (control voltage/contacts)	2.5		kV
Rated impulse withstand voltage, Leakage path and air gaps acc. to DIN VDE 0110-1	4		kV
Rated insulation voltage	250		V
Over voltage category according to DIN VDE 0110-1	3		
Safety contacts	2 NO contacts (redundant)		
Synchronization time	Max. 0.5		s
Release time for the safety relay (response time)	Max. 20		ms
Min. switching current at 24 V DC	20		mA
Switching voltage max.	24		V DC
	250		V AC
Breaking capacity acc. to \mathcal{U}	6 A 250 V AC 2 A 24 V DC		
Utilization category ²⁾ According to EN 60947-5-1	U_e	I_e	Σ I_e
	AC-12	250 V	6 A ³⁾
	AC-15	230 V	4 A
	DC-12	24 V	1.25 A ³⁾
	DC-13	24 V	2 A
LED indicators	2, status display for relays K1 and K2		
Reliability values acc. to EN ISO 13849-1			
Category	4		
Performance Level PL	e		

1) All the electrical connections must either be isolated from the mains supply by a safety transformer according to EN 61558-2-6 with limited output voltage in the event of a fault, or by other equivalent isolation measures.

2) See page 26 for information about the utilization category.

3) With Ohmic load.

U_e = switching voltage

I_e = max. switching current per contact

Σ I_e = max. switching current on all safety contacts (cumulative current)

Connection ESM-ES3..



Parameter	Value		Unit	
Operating voltage	ESM-ES301	24 ± 10% ¹⁾	V AC/DC	
	ESM-ES302	115 ± 10%	V AC	
	ESM-ES303	230 ± 10%	V AC	
Reverse polarity protection	On ESM-ES301			
Rated supply frequency	50 ... 60		Hz	
Power consumption	Approx. 4 VA / 2 W			
Control voltage at inputs	18.6 ... 26		V DC	
Control cable length (cross-section 0.75 mm ²)	Max. 1000		m	
External contact fuse (safety circuit) acc. to EN IEC 60269-1	10 A gG (T4A / F6A)			
Test voltage (control voltage/contacts)	2.5		kV	
Rated impulse withstand voltage, Leakage path and air gaps acc. to DIN VDE 0110-1	4		kV	
Rated insulation voltage	250		V	
Over voltage category according to DIN VDE 0110-1	3			
Cumulative current on all contacts acc. to Ⓢ	Max. 10.5		A	
Safety contacts	3 NO contacts (redundant)			
Min. switching current at 24 V DC	20		mA	
Switching voltage max.	50		V DC	
	250		V AC	
Breaking capacity acc. to Ⓢ (per contact)	6 A 250 V AC			
	2 A 24 V DC			
Utilization category ²⁾	U_e	I_e	Σ I_e	
According to EN 60947-5-1	AC-12	250 V	6 A ³⁾	10.5 A
	AC-15	230 V	4 A	
	DC-12	24 V	1.25 A ³⁾	
	DC-13	24 V	2 A	
LED indicators	2, status display for relays K1 and K2			
Auxiliary contact	1 NC contact			
Continuous current max.	500 ⁴⁾		mA	
Switching voltage max.	24		V AC/DC	
Reliability values acc. to EN ISO 13849-1				
Category	4			
Performance Level PL	e			

1) All the electrical connections must either be isolated from the mains supply by a safety transformer according to EN 61558-2-6 with limited output voltage in the event of a fault, or by other equivalent isolation measures.

2) See page 26 for information about the utilization category.

3) With Ohmic load.

4) As monitoring contact for safety relay.

U_e = switching voltage I_e = max. switching current per contact

Σ I_e = max. switching current on all safety contacts (cumulative current)

Connection ESM-TE3..



Parameter	Value	Unit		
Operating voltage	ESM-TE301	24 ± 10% ¹⁾		
	ESM-TE302	115 ± 10%		
	ESM-TE303	230 ± 10%		
Reverse polarity protection	On ESM-TE301			
Rated supply frequency	50 ... 60	Hz		
Power consumption	Approx. 4	VA		
Time-delay range	1 ... 30	s		
Fixed time delay ESM-TE301-05S	0.5 ²⁾	s		
Control voltage at inputs	18.6 ... 26	V DC		
Control cable length (cross-section 0.75 mm ²)	Max. 1000	m		
External contact fuse (safety circuit) acc. to EN IEC 60269-1	10 A gG (T4A / F6A)			
Test voltage (control voltage/contacts)	2.5	kV		
Rated impulse withstand voltage, Leakage path and air gaps acc. to DIN VDE 0110-1	4	kV		
Rated insulation voltage	250	V		
Over voltage category according to DIN VDE 0110-1	3			
Cumulative current on all contacts acc. to \mathcal{U}	Max. 10.5	A		
Safety contacts	3 NO contacts (redundant)			
Min. switching current at 24 V DC	20	mA		
Switching voltage max.	50	V DC		
	250	V AC		
Breaking capacity acc. to \mathcal{U} (per contact)	6 A 250 V AC			
	2 A 24 V DC			
Utilization category ³⁾ According to EN 60947-5-1	U_e	I_e	Σ I_e	
	AC-12	250 V	6 A ⁴⁾	10.5 A
	AC-15	250 V	4 A	
	DC-12	24 V	1.25 A ⁴⁾	
	DC-13	24 V	2 A	
LED indicators	2, status display for relays K1 and K2			
Auxiliary contact	1 NC contact			
Continuous current max.	500 ⁵⁾	mA		
Switching voltage max.	24	V DC		
Reliability values acc. to EN ISO 13849-1				
Category	3			
Performance Level PL	d			

1) All the electrical connections must either be isolated from the mains supply by a safety transformer according to EN 61558-2-6 with limited output voltage in the event of a fault, or by other equivalent isolation measures.

2) On ESM-TE301-05S the potentiometer is not required.

3) See page 26 for information about the utilization category.

4) With Ohmic load.

5) As monitoring contact for safety relay.

U_e = switching voltage I_e = max. switching current per contact

Σ I_e = max. switching current on all safety contacts (cumulative current)

Glossary

Feedback loop

Components connected downstream of the safety relay can be monitored for correct function. For this purpose normally closed contacts on these components are integrated into the feedback loop on the relay.

Relay start

After the relay has switched off due to a request from a safety component connected, the relay must be re-started. On this topic please pay attention to section 5.2.2 of EN ISO 13849-1:2008.

► Automatic start

The relay switches on automatically as soon as the safety component connected changes back to the safe state.

► Manual start

The relay is started by actuating a button. First the safe state of the safety components connected must be re-established.

► Monitored, manual start

The relay is started by actuating a button. The button is monitored for jamming or possible tampering. Prior to starting the relay the safe state of the safety components connected must be re-established.

Single-channel safety circuit

A single positively driven contact in the safety component is connected to the relay. This connection is suitable for categories 1 or 2 according to EN ISO 13849-1.

Dual-channel safety circuit

Two contacts of which at least one is a positively driven contact are connected to the relay. This connection is suitable for categories 3 or 4 according to EN ISO 13849-1.

Utilization category according to EN 60947-5-1 (extract)

Voltage type	Utilization category	Typical applications
AC	AC-12	Controlling resistive load and semiconductor load in input circuits of optocouplers
	AC-15	Controlling electro-magnetic load (> 72 VA)
DC	DC-12	Controlling resistive load and semiconductor load in input circuits of optocouplers
	DC-13	Controlling electro-magnetic loads with economy resistors in the circuit

Connection examples safety relay ESM

Safety relay ESM-BL..

Automatic start without integration of the feedback loop

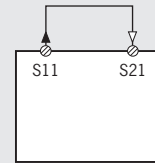

Manual start without integration of the feedback loop

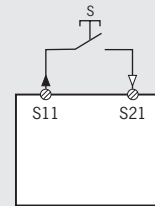

Automatic start with integration of the feedback loop

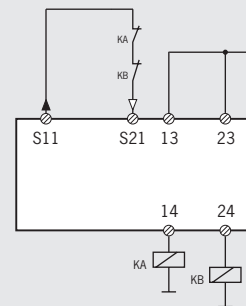

Manual start with integration of the feedback loop

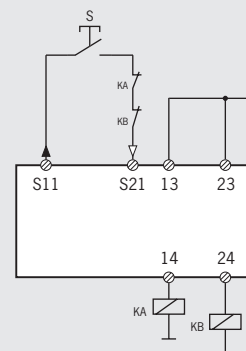

Emergency stop/safety circuit

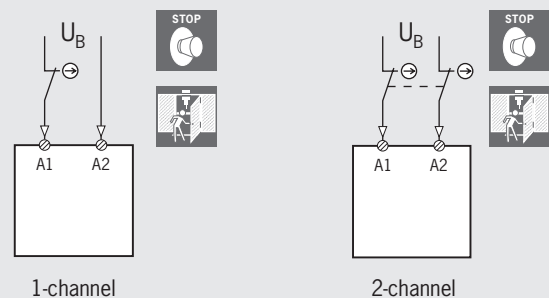

Safety relays ESM-BA../ESM-BT..

Monitored start without integration of the feedback loop

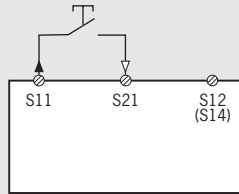

Un-monitored start without integration of the feedback loop

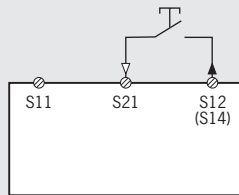

Automatic start without integration of the feedback loop

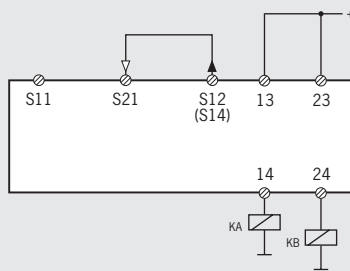

Monitored start with integration of the feedback loop

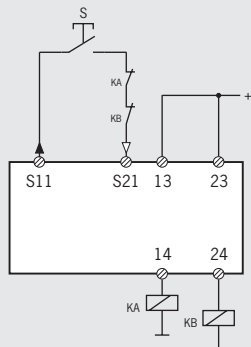

Un-monitored start with integration of the feedback loop

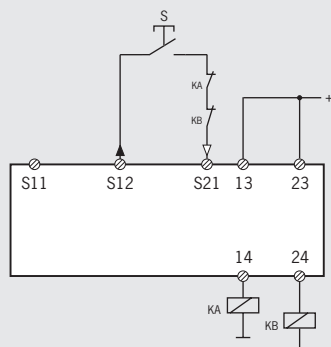

Automatic start with integration of the feedback loop

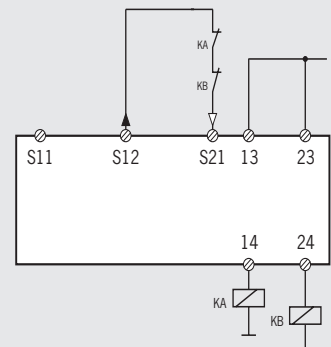

1-channel emergency stop/safety circuit

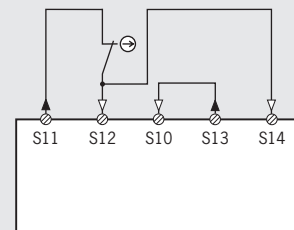

2-channel emergency stop/safety circuit with ground fault/short circuit detection

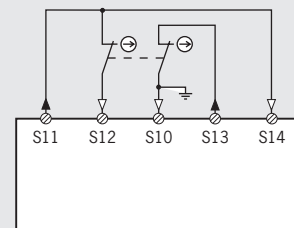

2-channel emergency stop/safety circuit with connection for MGB, CES-AR and light curtains

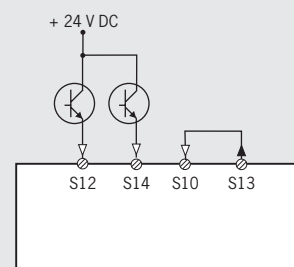

Safety relay ESM-2H2..

Monitoring a 2-hand control

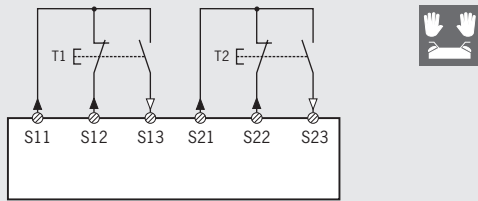

With integration of the feedback loop

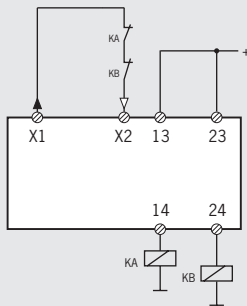

Without integration of the feedback loop

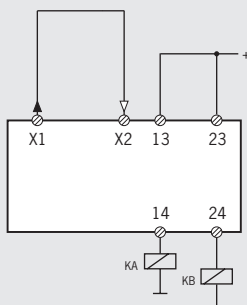

Safety contact expansion ESM-ES../ESM-TE..

Integration of the contact expansion

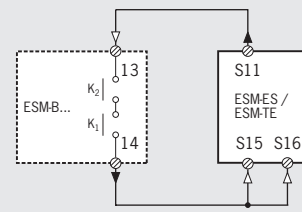

Connection of the contact expansion with automatic start and with integration of the feedback loop

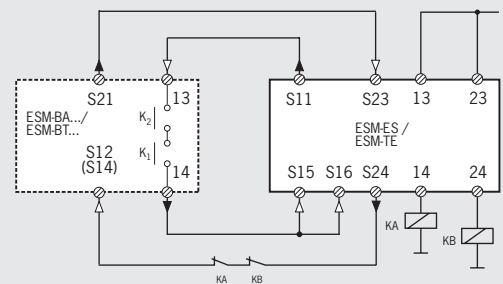

Connection of the contact expansion with manual start and with integration of the feedback loop

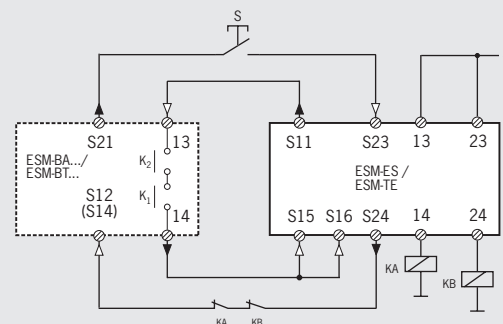

Index by item designation

Item	Order no.	Page
ESM-2H201	085 620	13
ESM-2H202	098 345	13
ESM-BA201	085 610	9
ESM-BA201P	097 226	9
ESM-BA202	085 611	9
ESM-BA203	085 612	9
ESM-BA301	085 613	10
ESM-BA301P	097 230	10
ESM-BA302	087 412	10
ESM-BA303	087 413	10
ESM-BA701P	097 225	11
ESM-BL201	085 607	8
ESM-BL202	085 608	8
ESM-BL203	085 609	8
ESM-BT401	090 818	12
ESM-BT411	090 819	12
ESM-BT421	090 820	12
ESM-ES301	085 614	14
ESM-ES302	085 615	14
ESM-ES303	085 616	14
ESM-F-AK4	097 194	16
ESM-F-KK4	097 195	16
ESM-TE301	085 617	15
ESM-TE301-05S	097 223	15
ESM-TE302	085 618	15
ESM-TE303	085 619	15

Index by order number

Order no.	Item	Page
085 607	ESM-BL201	8
085 608	ESM-BL202	8
085 609	ESM-BL203	8
085 610	ESM-BA201	9
085 611	ESM-BA202	9
085 612	ESM-BA203	9
085 613	ESM-BA301	10
085 614	ESM-ES301	14
085 615	ESM-ES302	14
085 616	ESM-ES303	14
085 617	ESM-TE301	15
085 618	ESM-TE302	15
085 619	ESM-TE303	15
085 620	ESM-2H201	13
087 412	ESM-BA302	10
087 413	ESM-BA303	10
090 818	ESM-BT401	12
090 819	ESM-BT411	12
090 820	ESM-BT421	12
097 194	ESM-F-AK4	16
097 195	ESM-F-KK4	16
097 223	ESM-TE301-05S	15
097 225	ESM-BA701P	11
097 226	ESM-BA201P	9
097 230	ESM-BA301P	10
098 345	ESM-2H202	13

Representatives

International

Australia

Micromax Sensors & Automation
Unit 2, 106-110 Beaconsfield Street
Silverwater, NSW 2128
Tel. +61 2 87482800
Fax +61 2 96482345
info@micromaxsa.com.au

Austria

EUCHNER GmbH
Süddruckgasse 4
2512 Tribuswinkel
Tel. +43 2252 42191
Fax +43 2252 45225
info@euchner.at

Benelux

EUCHNER (BENELUX) BV
Visschersbuurt 23
3356 AE Papendrecht
Tel. +31 78 615-4766
Fax +31 78 615-4311
info@euchner.nl

Brazil

EUCHNER Ltda
Av. Prof. Luiz Ignácio Anhaia Mello,
no. 4387
S. Lucas
São Paulo - SP - Brasil
CEP 03295-000
Tel. +55 11 29182200
Fax +55 11 23010613
euchner@euchner.com.br

Canada

IAC & Associates Inc.
2180 Fasan Drive
Unit A
Oldcastle, Ontario
NOR 1L0
Tel. +1 519 737-0311
Fax +1 519 737-0314
sales@iacnassociates.com

China

EUCHNER (Shanghai)
Trading Co., Ltd.
No. 8 Workshop A, Hi-Tech Zone
503 Meinengda Road Songjiang
201613 Shanghai
Tel. +86 21 5774-7090
Fax +86 21 5774-7599
info@euchner.com.cn

Czech Republic

EUCHNER electric s.r.o.
Videňská 134/102
61900 Brno
Tel. +420 533 443-150
Fax +420 533 443-153
info@euchner.cz

Denmark

Duelco A/S
Systemvej 8
9200 Aalborg SV
Tel. +45 7010 1007
Fax +45 7010 1008
info@duelco.dk

Finland

Sähkölehto Oy
Holkkitie 14
00880 Helsinki
Tel. +358 9 7746420
Tel. +358 9 7746420
Fax +358 9 7591071
office@sahkolehto.fi

France

EUCHNER France S.A.R.L.
Parc d'Affaires des Bellevues
Allée Rosa Luxembourg
Bâtiment le Colorado
95610 ERAGNY sur OISE
Tel. +33 1 39099090
Fax +33 1 39099099
info@euchner.fr

Hong Kong

Imperial
Engineers & Equipment Co. Ltd.
Unit B 12/F
Cheung Lee Industrial Building
9 Cheung Lee Street Chai Wan
Hong Kong
Tel. +852 2889 0292
Fax +852 2889 1814
info@imperial-elec.com

Hungary

EUCHNER Ges.mBH
Magyarországi Fióktelep
2045 Törökbálint
FSD Park 2.
Tel. +36 2342 8374
Fax +36 2342 8375
info@euchner.hu

India

EUCHNER (India) Pvt. Ltd.
401, Bremen Business Center,
City Survey No. 2562,
University Road
Aundh, Pune - 411007
Tel. +91 20 64016384
Fax +91 20 25885148
info@euchner.in

Israel

Ilan & Gavish Automation Service Ltd.
26 Shenkar St. Qiryat Arie 49513
P.O. Box 10118
Petach Tikva 49001
Tel. +972 3 9221824
Fax +972 3 9240761
mail@ilan-gavish.com

Essen/Dortmund

Thomas Kreißl
fördern - steuern - regeln
Hackenbergweg 8a
45133 Essen
Tel. +49 201 84266-0
Fax +49 201 84266-66
info@kreissl-essen.de

Wiesbaden

EUCHNER GmbH + Co. KG
Ingenieur- und Vertriebsbüro
Schiersteiner Straße 28
65187 Wiesbaden
Tel. +49 611 98817644
Fax +49 611 98895071
giancarlo.pasquesi@euchner.de

Italy

TRITECNICA S.r.l.
Viale Lazio 26
20135 Milano
Tel. +39 02 541941
Fax +39 02 55010474
info@tritecnica.it

Japan

EUCHNER
Representative Office Japan
8-20-24 Kamitsurumhoncho
Minami-ku, Sagami-hara-shi
Kanagawa 252-0318
Tel. +81 42 8127767
Fax +81 42 7642708
hayashi@euchner.jp

Solton Co. Ltd.

2-13-7, Shin-Yokohama
Kohoku-ku, Yokohama
Japan 222-0033
Tel. +81 45 471-7711
Fax +81 45 471-7717
sales@solton.co.jp

Korea

EUCHNER Korea Co., Ltd.
RM 810 Daerung Technotown 3rd
#448 Gasang-Dong
Gumcheon-gu, Seoul
Tel. +82 2 2107-3500
Fax +82 2 2107-3999
info@euchner.co.kr

Mexico

SEPIA S.A. de C.V.
Maricopa # 10
302, Col. Napoles.
Del. Benito Juarez
03810 Mexico D.F.
Tel. +52 55 55367787
Fax +52 55 56822347
alazcano@sepia.mx

Poland

ELTRON
Pl. Wolności 7B
50-071 Wrocław
Tel. +48 71 3439755
Fax +48 71 3460225
eltron@eltron.pl

Republic of South Africa

RUBICON
ELECTRICAL DISTRIBUTORS
4 Reith Street, Sidwell
6061 Port Elizabeth
Tel. +27 41 451-4359
Fax +27 41 451-1296
sales@rubiconelectrical.com

Romania

First Electric SRL
Str. Ritmului Nr. 1 Bis
Ap. 2, Sector 2
021675 Bucuresti
Tel. +40 21 2526218
Fax +40 21 3113193
office@firstelectric.ro

Singapore

Sentronics
Automation & Marketing Pte Ltd.
Blk 3, Ang Mo Kio Industrial Park 2A
#05-06
Singapore 568050
Tel. +65 6744 8018
Fax +65 6744 1929
sentronics@pacific.net.sg

Slovakia

EUCHNER electric s.r.o.
Videňská 134/102
61900 Brno
Tel. +420 533 443-150
Fax +420 533 443-153
info@euchner.cz

Slovenia

SMM proizvodni sistemi d.o.o.
Jaskova 18
2000 Maribor
Tel. +386 2 4502326
Fax +386 2 4625160
franc.kit@smm.si

Spain

EUCHNER, S.L.
Gurutzegi 12 - Local 1
Polígono Belartza
20018 San Sebastian
Tel. +34 943 316-760
Fax +34 943 316-405
comercial@euchner.es

Sweden

Censit AB
Box 331
33123 Värnamo
Tel. +46 370 691010
Fax +46 370 18888
info@censit.se

Switzerland

EUCHNER AG
Grofstrasse 17
8887 Mels
Tel. +41 81 720-4590
Tel. +41 81 720-4599
info@euchner.ch

Taiwan

Daybreak Int'l (Taiwan) Corp.
3F, No. 124, Chung-Cheng Road
Shihlin 11145, Taipei
Tel. +886 2 8866-1234
Fax +886 2 8866-1239
day111@ms23.hinet.net

Turkey

Entek Otomasyon Urunleri
San.ve Tic.Ltd.Sti.
Perpa Tic.Mer. B Blok
Kat: 11 No:1622 - 1623
34384 Okmeydani / Istanbul
Tel. +90 212 320-2000 / 01
Fax +90 212 320-1188
entekotomasyon@entek.com.tr

Germany

Chemnitz

EUCHNER GmbH + Co. KG
Ingenieur- und Vertriebsbüro
Am Vogelherd 2
09627 Bobritzsch
Tel. +49 37325 906000
Fax +49 37325 906004
jens.zehrtner@euchner.de

Düsseldorf

EUCHNER GmbH + Co. KG
Ingenieur- und Vertriebsbüro
Sunderholz 24
45134 Essen
Tel. +49 201 43083-93
Fax +49 201 43083-94
juergen.eumann@euchner.de

Freiburg

EUCHNER GmbH + Co. KG
Ingenieur- und Vertriebsbüro
Steige 5
79206 Breisach
Tel. +49 7664 4038-33
Fax +49 7664 4038-34
peter.seifert@euchner.de

Hamburg

EUCHNER GmbH + Co. KG
Ingenieur- und Vertriebsbüro
Bleickenallee 13
22763 Hamburg
Tel. +49 40 636740-57
Fax +49 40 636740-58
volker.behrens@euchner.de

Magdeburg

EUCHNER GmbH + Co. KG
Ingenieur- und Vertriebsbüro
Tismarstraße 10
39108 Magdeburg
Tel. +49 391 736279-22
Fax +49 391 736279-23
bernhard.scholz@euchner.de

München

EUCHNER GmbH + Co. KG
Ingenieur- und Vertriebsbüro
Obere Bahnhofstraße 6
82110 Germering
Tel. +49 89 800846-85
Fax +49 89 800846-90
st.kornes@euchner.de

United Kingdom

EUCHNER (UK) Ltd.
Unit 2 Petre Drive,
Sheffield
South Yorkshire
S4 7PZ
Tel. +44 114 2560123
Fax +44 114 2425333
info@euchner.co.uk

USA

EUCHNER USA Inc.
6723 Lyons Street
East Syracuse, NY 13057
Tel. +1 315 701-0315
Fax +1 315 701-0319
info@euchner-usa.com

EUCHNER USA Inc.

Detroit Office
130 Hampton Circle
Rochester Hills, MI 48307
Tel. +1 248 537-1092
Fax +1 248 537-1095
info@euchner-usa.com



EUCHNER

More than safety.



Support hotline

You have technical questions about our products or how they can be used?
For further questions please contact your local sales representative.



Comprehensive download area

You are looking for more information about our products?
You can simply and quickly download operating instructions, CAD or ePLAN data and accompanying software for our products at www.euchner.com.



Customer-specific solutions

You need a specific solution or have a special requirement?
Please contact us. We can manufacture your custom product even in small quantities.



EUCHNER near you

You are looking for a contact at your location? Along with the headquarters in Leinfelden-Echterdingen, the worldwide sales network includes 14 subsidiaries and numerous representatives in Germany and abroad – you will definitely also find us near you.

www.euchner.com

EUCHNER GmbH + Co. KG

Kohlhammerstraße 16
70771 Leinfelden-Echterdingen
Germany
Tel. +49 711 7597-0
Fax +49 711 753316
info@euchner.de
www.euchner.com

EUCHNER

More than safety.